



LUMINYS

Camera Accessory Diagrams V1



April 2026

Mounting Guide

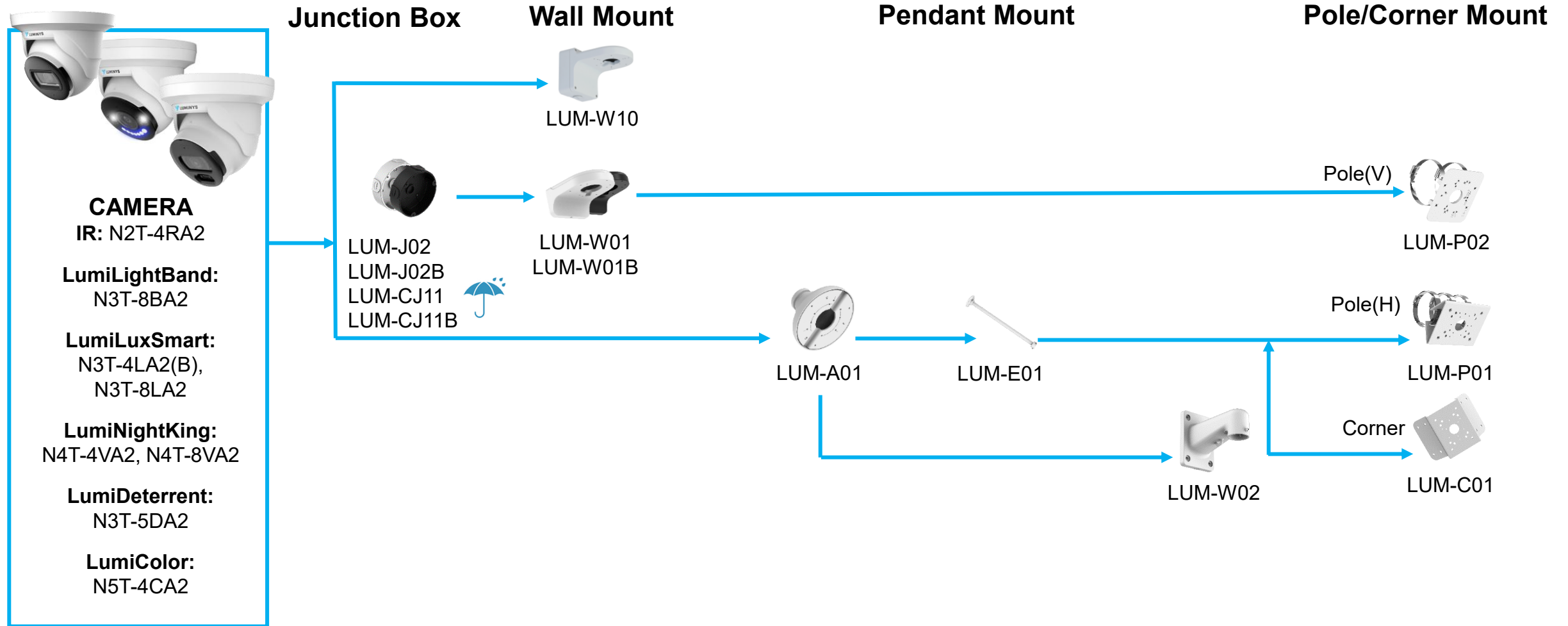

*Design and specifications are subject to change without notice.
Small Turret Mount Guide V1.3*

Mounting Guide

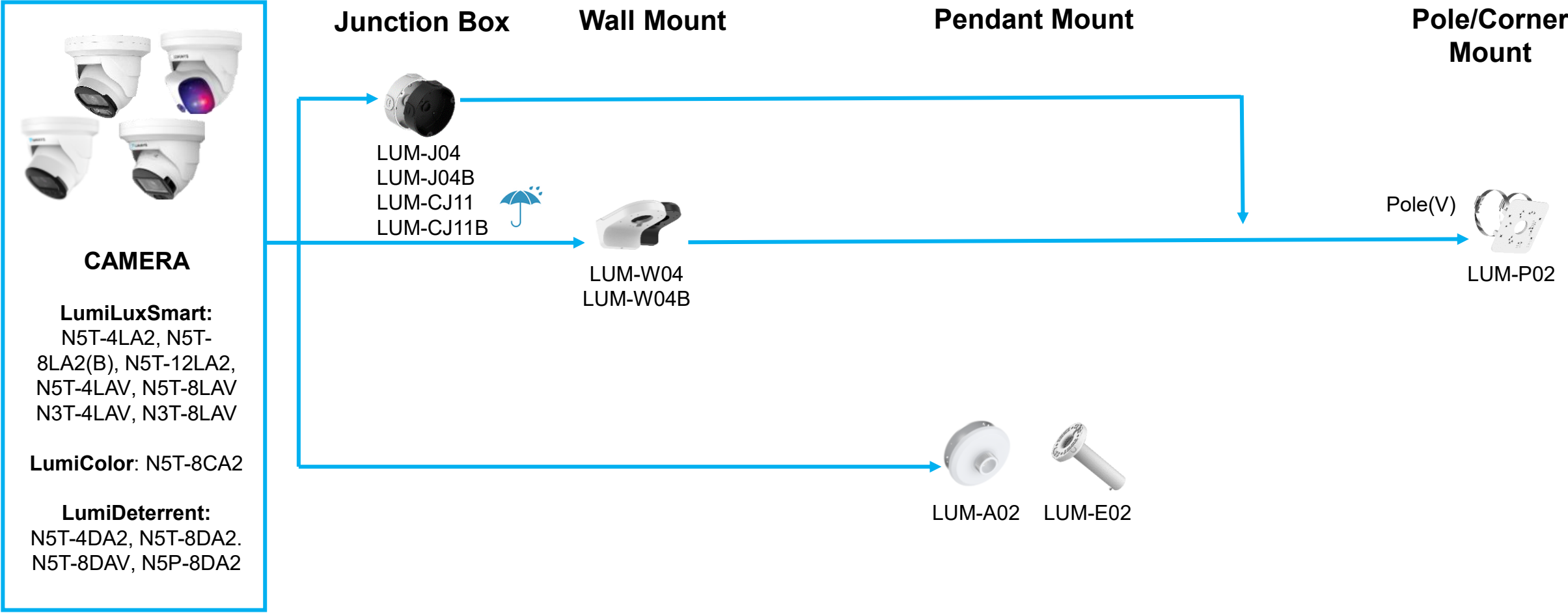

*Design and specifications are subject to change without notice.
Standard Turret Mount Guide V1*

Mounting Guide

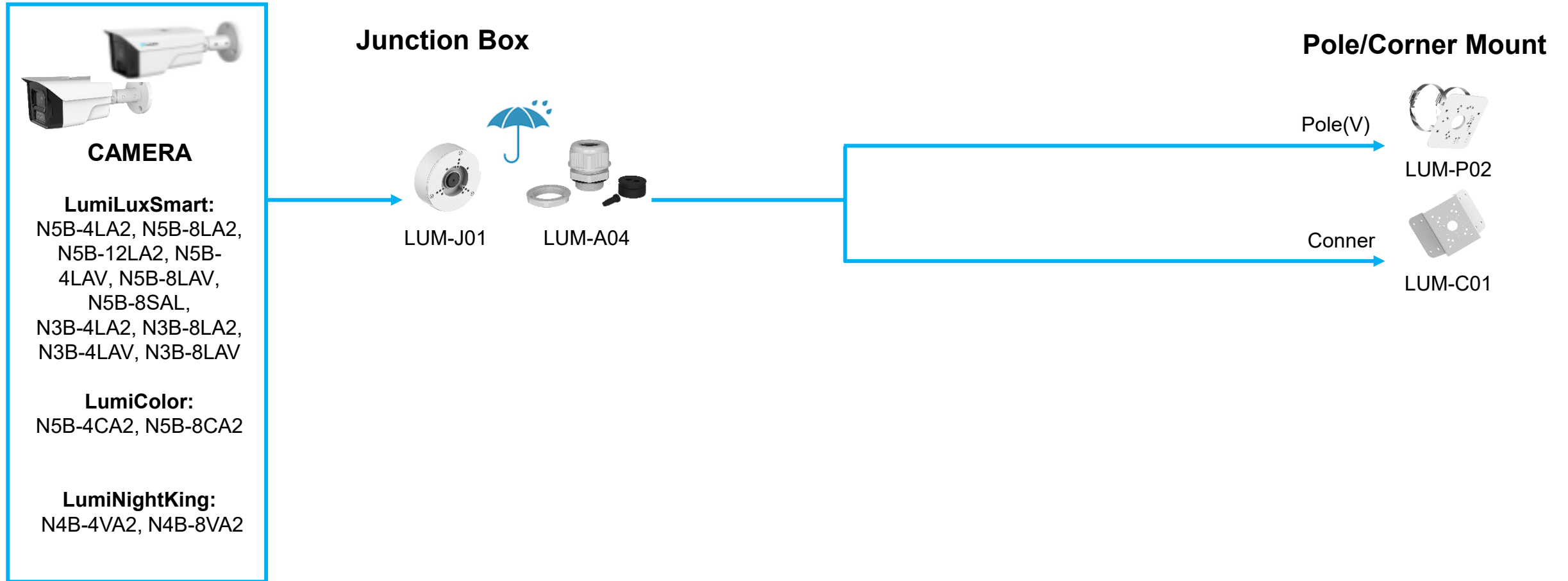

Mounting Guide

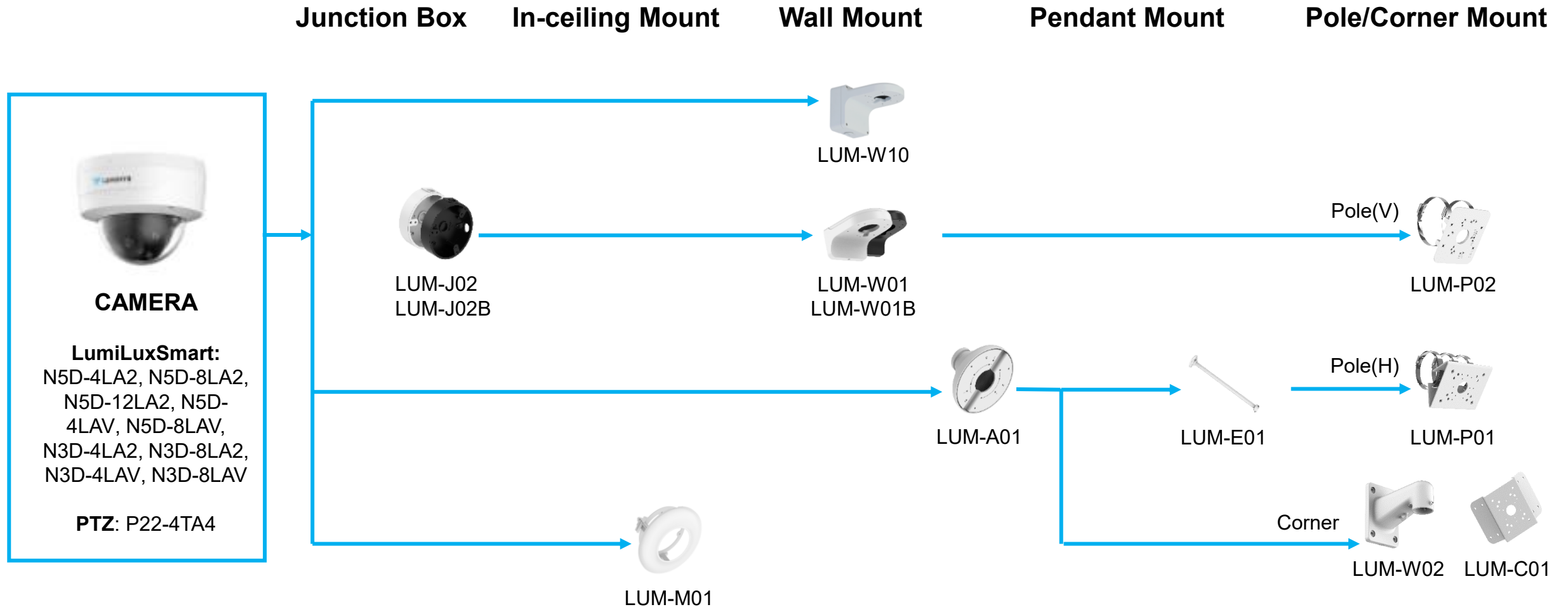

Mounting Guide

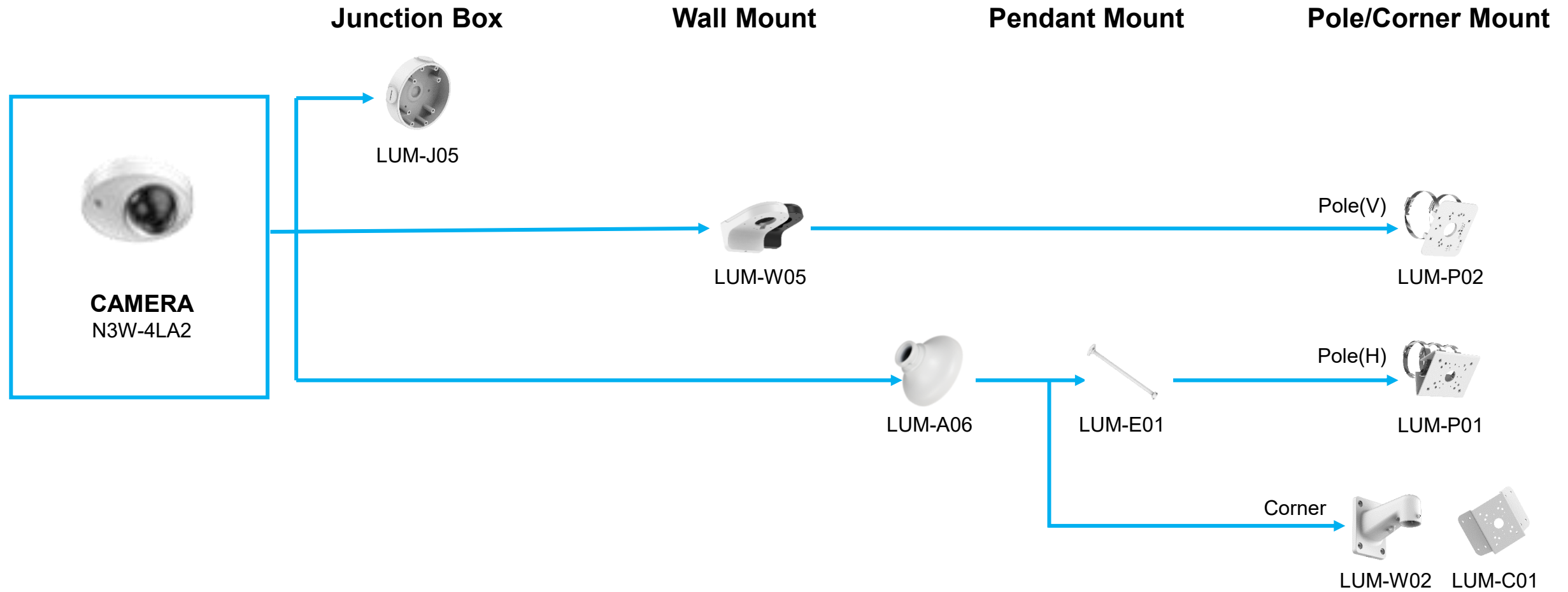

Mounting Guide

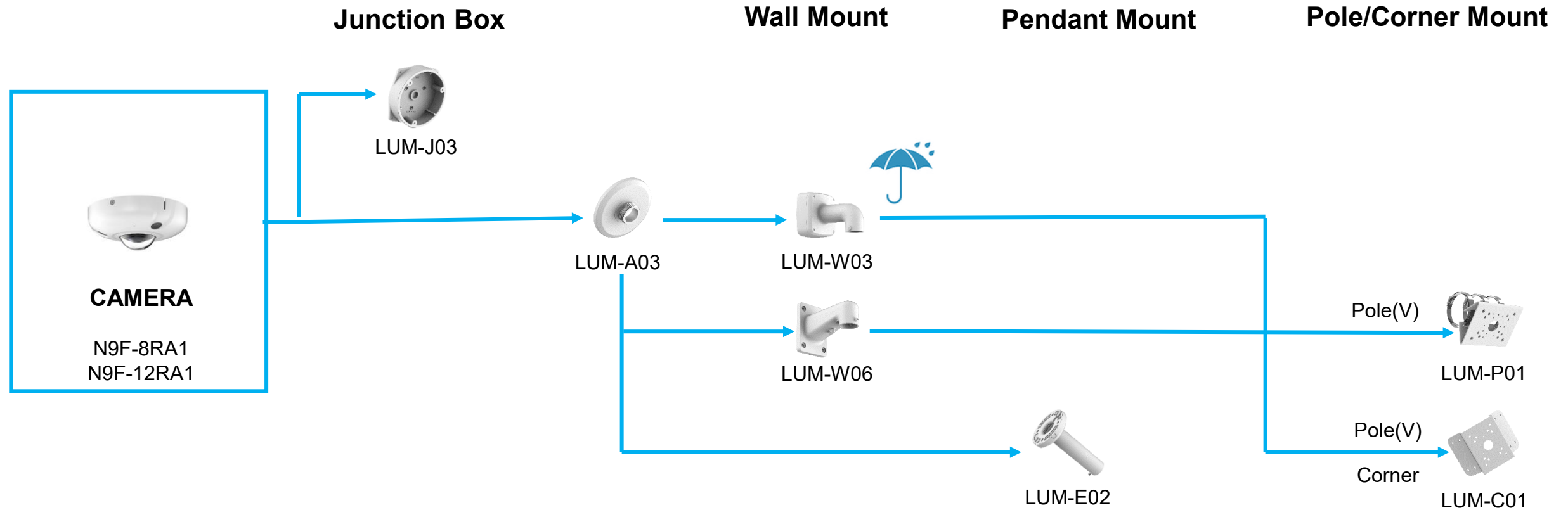

Mounting Guide

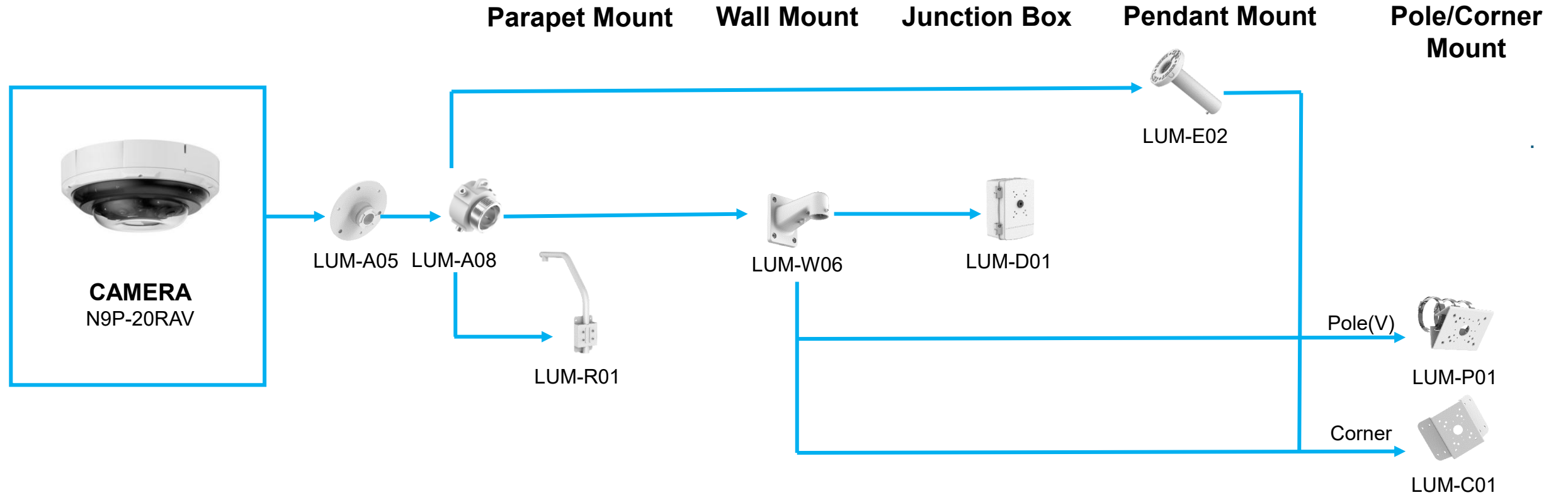

Mounting Guide

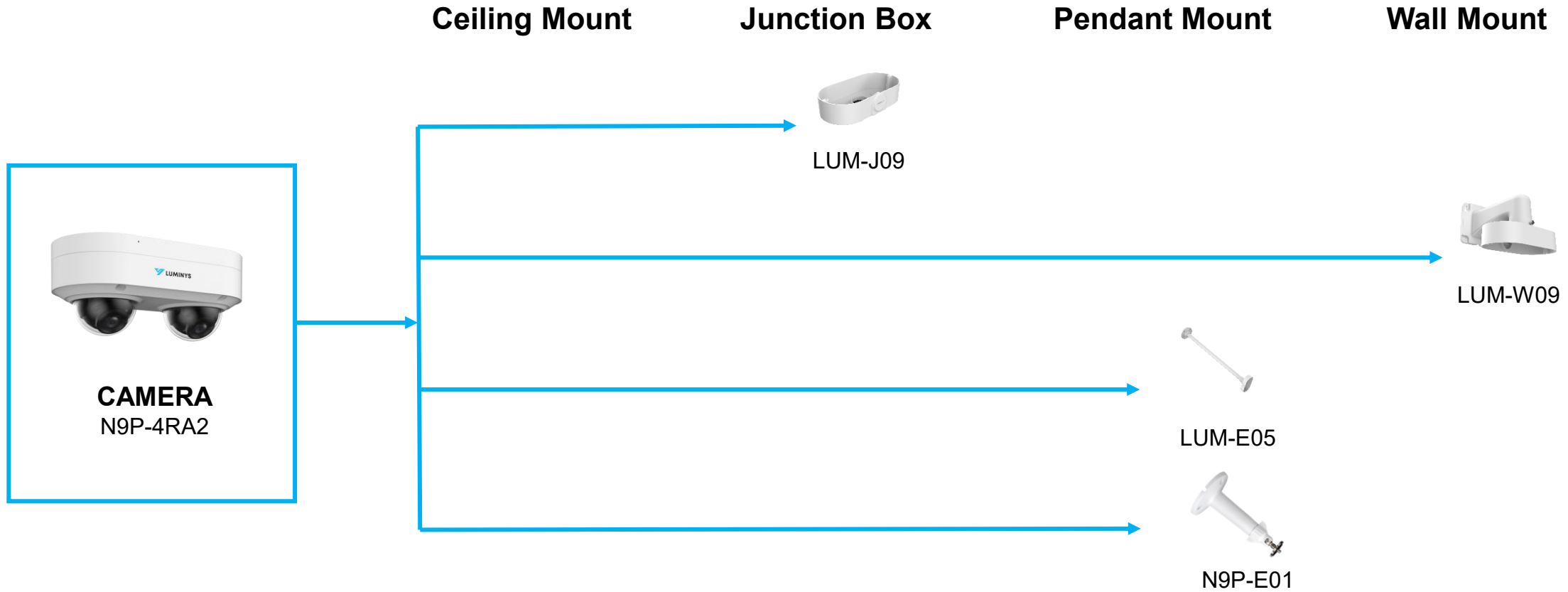

Mounting Guide



Pole Mount



LUM-P01

Mounting Guide

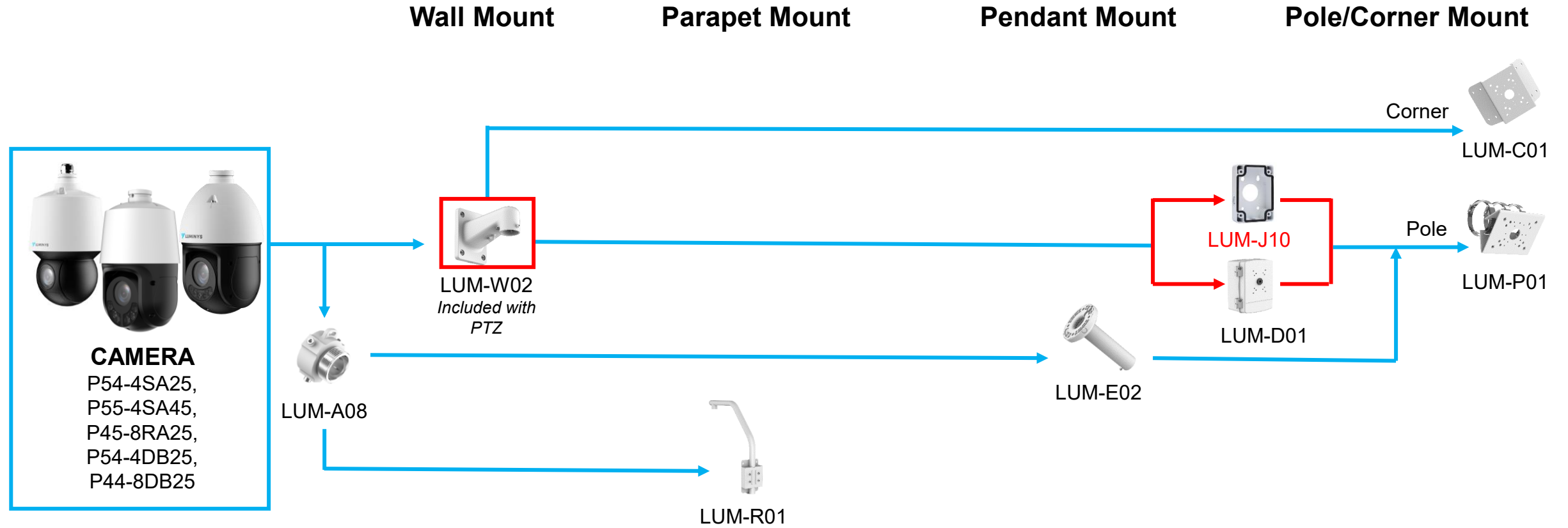

Mounting Guide

